

成型孔:11A-3

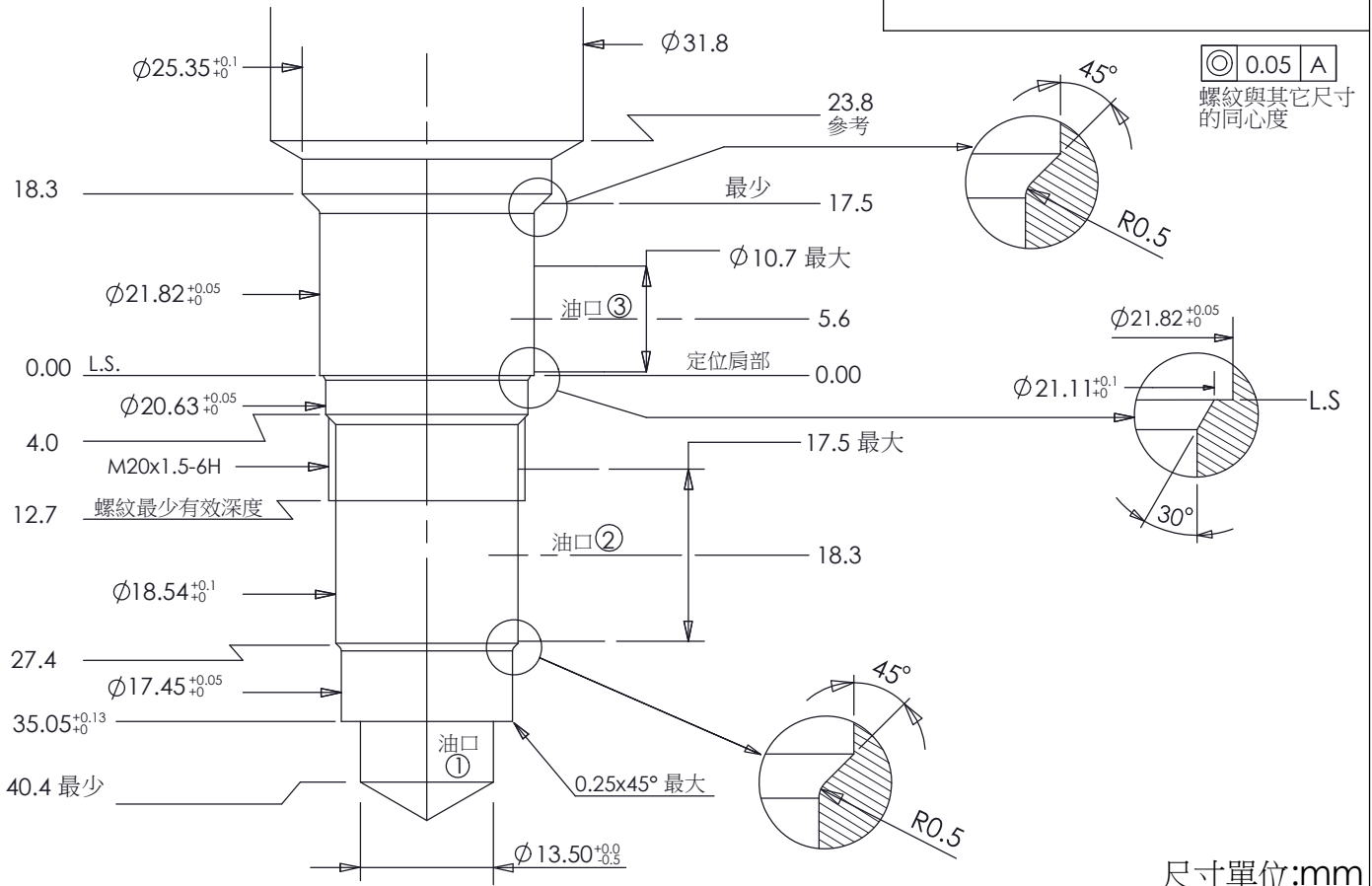

成型孔:2A-3

